

SH PLANNING

SKIRTING HEATING. INDIVIDUAL.



50/40 °C
186 W/m
(Type Ia)

Classic skirting heating.
Delta skirting heating.

www.variotherm.com

VARIOTHERM

TABLE OF CONTENTS

1	PRINCIPLES	4
1.1	What does a veil have to do with skirting heating systems?	4
1.2	The Coandă effect	4
1.3	Comfort	4
1.4	Energy savings	6
1.5	Method of operation of the skirting heating system	6
1.6	Temperature curve	6
1.7	Areas of application	7
1.8	Description and Advantages	8
2	COMPONENTS	9
2.1	Overview – Classic skirting heating	9
2.2	Overview – Delta skirting heating	10
2.3	Heating elements	12
2.4	Accessories for connection to the VarioManifold	12
2.5	Accessories for connection to the two-pipe system	13
2.6	Connection accessories	13
3	PIPING WITH THE VARIOMANIFOLD	14
3.1	Description	14
3.2	Piping components	15
4	PIPING WITH A TWO-PIPE SYSTEM	16
4.1	Description	16
4.2	Supply pipes inside the cladding	17
4.3	Vent	17
4.4	Piping components	17
5	THERMAL OUTPUT	20
5.1	Calculation of the thermal load	20
5.2	Variotherm dimensioning software	20
5.3	Heat output tables	21
6	DIMENSIONING	22
6.1	General planning principles	22
6.2	Positioning of the supply pipe	23
6.3	Skirting heating with special shapes (on request)	23
7	DETAIL DRAWINGS	24

1 PRINCIPLES

1.1 What does a veil have to do with skirting heating systems?

A veil has a simple function: It blocks something. The same applies to the hot air veil created by the Variotherm skirting heating system, which covers cold walls within a short period of time. This shields the cold radiation from the walls and simultaneously warms the walls. When this happens, a feeling of cosiness starts spreading throughout the room, replacing the cold. The heated walls give off radiant, long-wavelength infrared heat, which warms the room. Radiant heat is particularly pleasant since, like solar heat, it is similar to our body's natural warmth. Radiant heat is the traditional form of heat, such as radiated by tiled stoves. It is healthy and natural!

1.2 The Coandă effect

The Coandă effect is the physical requirement for the skirting heating system's effect: At the beginning of the 20th century, physicist Henri Coandă discovered that rising hot air always follows cold surfaces (e.g. glass surfaces and exterior walls) as it ascends: When air currents exit slits at a certain angle and distance, the current will bend towards the surface due to the created turbulences and the lower pressure on one side. The air current will "stick" to it as long as certain requirements (distances and flow thickness) are met. The low pressure area around the secondary air introduced by the flow over a surface is crucial for this effect. If this secondary air cannot continue to flow, the current will draw itself into this area, or follow the wall. This law of physics is the reason why the Variotherm skirting heating system works in such an outstanding way. Thanks to the Coandă effect, they also have another advantage: Only a small amount of dust is stirred up because the heating system generates only a very small amount of air movement. A blessing for your respiratory tract!

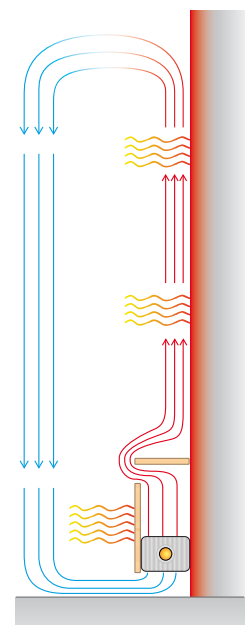

▲ Coandă effect

1.3 Comfort

Cosiness is not only created through a certain air temperature in the room. The temperature of the surfaces enclosing the room is of equal importance. The perceived temperature is roughly consistent with the arithmetic mean of both temperatures.

What makes people feel comfortable?

People feel comfortable when the following basic "thermal comfort" equation holds:

$$\text{Heat production} = \text{heat loss}$$

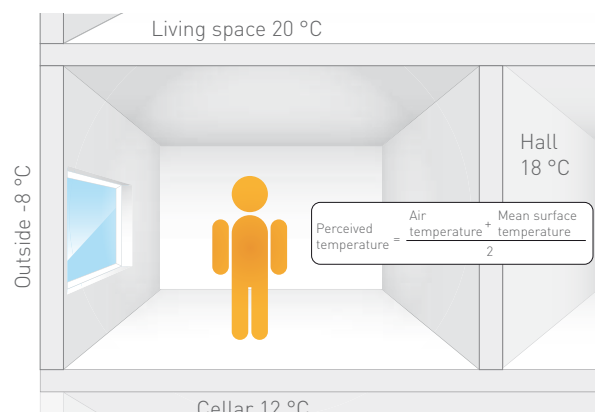

▲ Perceived temperature

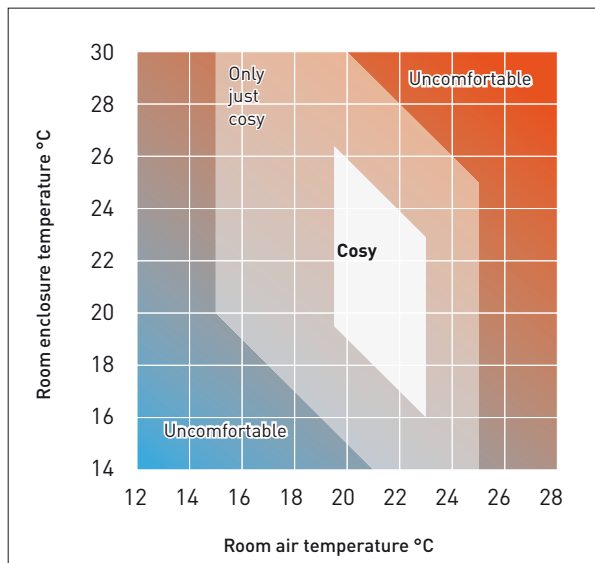

▲ Zone of cosiness

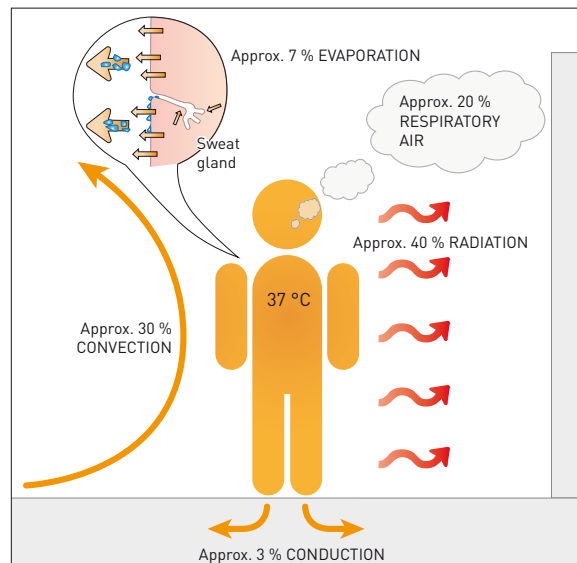

▲ Human heat balance

An important aspect of heat output from the human body is that this should occur as evenly as possible from all sides. We feel uncomfortable if too much heat is lost in one particular direction (e.g. cold surfaces, forced air) or the heat output is prevented in one direction (hot surfaces or vapour-tight, thick clothing). The lower the inside air temperature, the warmer the surrounding surfaces (wall surfaces, floor and ceiling, as well as doors and windows) must be to ensure cosiness.

Compared to other heating systems, a skirting heating system increases comfort. The installation of a skirting heating system along an exterior wall, especially under windows, can largely cancel out the unpleasant effects from the radiation exchange between your body and cold exterior walls and windows. You can set the room temperature lower than you would with convection heating without worrying about discomfort, since the hot air veil raises the perceived air temperature.

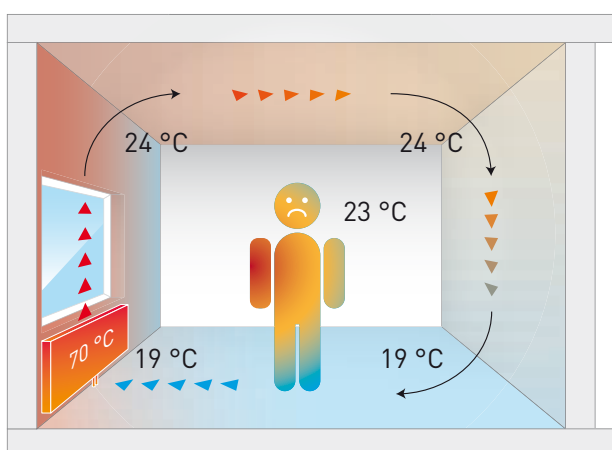

▲ Discomfort with radiators:
Heated air rises quickly and returns to the floor as cold air.
> Unbalanced temperature distribution, stirred dust caused by circulating air, "dry air"

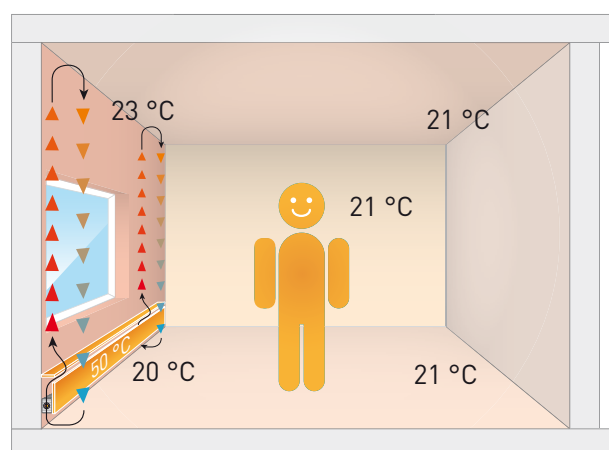

▲ Comfort with Variotherm skirting heating systems:
The even heating of floor and walls creates a cosy warm envelop in the entire room.
> Healthy room climate, hardly any dust stirred up, no over-heated floor, no overheated ceiling, "very cosy"

1.4 Energy savings

Energy losses are significantly reduced through an optimised ambient air temperature in conjunction with increased comfort. The approximate cost savings are 6 % per 1 °C reduction of room air temperature. This has the additional great physiological advantage of significantly increasing the absorption of oxygen in the body. At the same time, the relative humidity increases and produces healthier air that is also easier to breathe. Compared with other hot water heating systems, trench heating systems run with the lowest amount of water. They are therefore the fastest and most precise hot water heating systems.

1.5 Method of operation of the skirting heating system

The goal of skirting heating systems is to maintain the right wall temperature. This is why they are installed along the entire length of the outside wall when possible. The air flows from bottom to top through the skirting heating system and then selects the area right next to the wall as a channel to ascend along due to the higher temperature difference (see also Coandă effect, section 1.2). On its way up, it continuously gives off its heat to the wall before stratifying within the room air. The heated wall surface turns into a heat radiating surface. This allows for a cosy indoor temperature with low temperature differences within the room, and between outside and interior wall surfaces.

The following infrared images show the rapid effect of Variotherm skirting heating systems. A veil of warm air is developed in just a few minutes. It blocks off the cold and heats the wall.

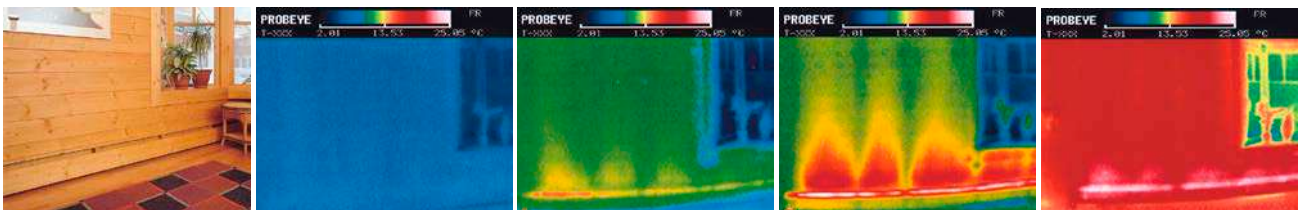

1.6 Temperature curve

The image shows the variation in temperature within the room of a home heated with a Variotherm skirting heating system, as measured by a calibrated temperature probe. It is easy to see that there is little difference in temperature between the floor and the ceiling. The dashed lines indicate the apparent radiant heat as measured by the probe. It is significantly higher than the actual room air temperature. This proves that cosiness is already achieved at lower, energy-saving room air temperatures.

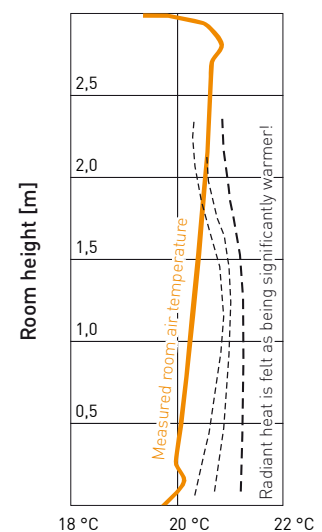

1.7 Areas of application

Skirting heating systems are suitable for new homes and renovations. They can be installed in conventional 2-pipe systems or manifold systems. When renovating, existing rising lines can be used for supply. In any case, another ace of skirting heating systems comes to bear. The cladding can be used to elegantly 'hide' the required heating pipes (and electrical cables). Humid walls prone to mould formation can be renovated with skirting heating systems. Thanks to the temperate walls along the entire height of the room, the relative humidity even in poorly ventilated corners does not reach critical values any more (extreme cases need to be considered from case to case). Owing to their low construction heights, skirting heating systems are very suitable for low windows (low parapet height). Hotel rooms, and rooms in cellars that are used less often, can be used again in a shorter amount of time. Skirting heating systems meet these criteria due to their low latency and homogeneous heat output. Depending on the design, rooms are heated to a cosy level within 15 to 30 minutes.

How do the required installation lengths of the skirting heating system match the planned furnishing?

Skirting heating systems are installed on the exterior walls where furniture is not supposed to be placed (or at least not without any problems). Tall furniture would limit natural light. Placement possibilities are also limited by windows and curtains. In rooms with large wardrobes, cupboards or shelves, Variotherm skirting heating systems can be integrated into them. In case of less well-insulated homes, it is not recommended to place furniture along the exterior walls due to mould formation. When planned ahead in time, skirting heating systems can also be integrated in niches. Variotherm skirting heating systems can be installed on the lower part of the wall, in plinths or in niches.

Furniture can then be placed as desired. With parquet floors and wood panelling, the skirting heating system can be encased in wood.

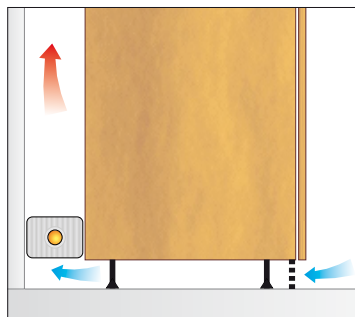

▲ Kitchen installation

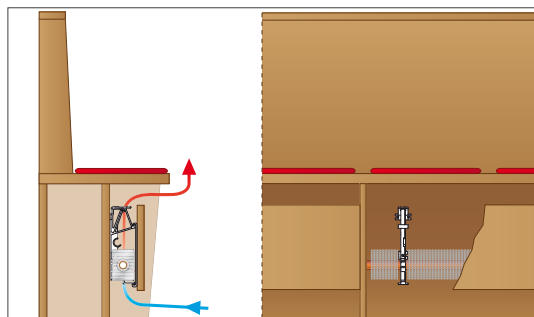

▲ Classic skirting heating system under the pew

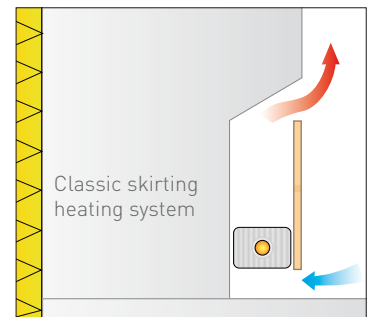

▲ Skirting heating system in the wall construction - section

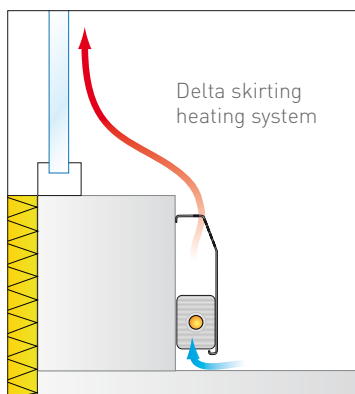

▲ Skirting heating system in front of glass surfaces



▲ Skirting heating system below glass surfaces

1.8 Description and Advantages

The skirting heating systems are optimally suited for shielding cold exterior walls in new buildings and renovated buildings. All components are perfectly matched to each other.

- The heating element specifically developed by Variotherm
- Well-thought-out brackets to mount the heating element and fixate the cladding at the same time
- Three cladding options – perfect for all rooms
- Features a wide range of control options

All this makes for a perfect combination. Down to the smallest detail.

Classic

The cladding of the Classic heating elements is provided by the customer (for example with wood). This allows the cladding to be optimally adapted to the furniture and the floor. For dimensioning, see chapter 7.

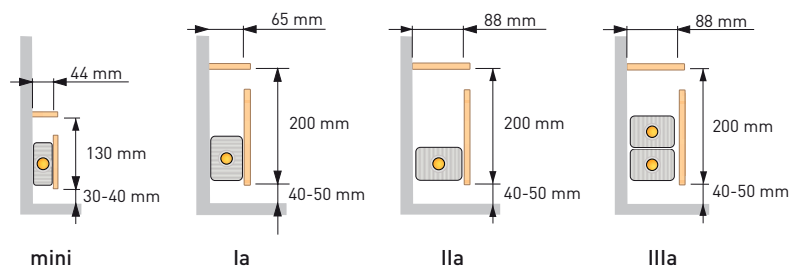

Delta

The metal cladding is included with the Delta skirting heating. The elegant steel sheet (1 mm) cladding is powder-coated in white by default (RAL 9001). Other RAL colours and colour effects (for example metallic) are available upon request.

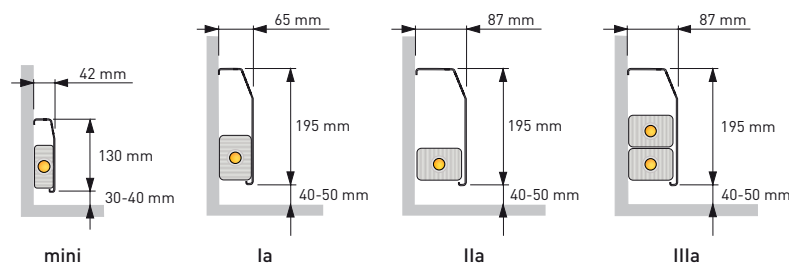

The advantages:

- Hot water heating system works in seconds
- Environmentally friendly and energy-saving
- Extremely flexible and individual
- The influence of cold from cool surfaces is effectively screened off
- Elegant, discrete and flexible design
- Combats damp and mould formation on walls
- Different types available to suit the required output



2 COMPONENTS

2.1 Overview – Classic skirting heating

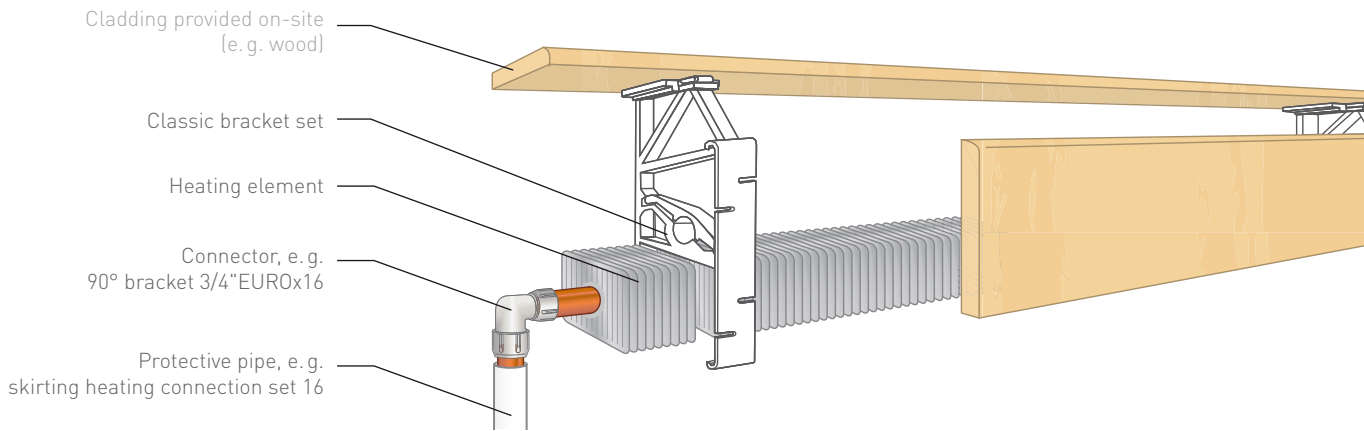

Heating elements

- Copper pipe $\varnothing 18 \times 0.5$ mm
- Aluminium louvres 35×78 mm (mini) or 56×78 mm
- Suitable for low temperature
- Optimised heat transfer
- Austrian seal of quality

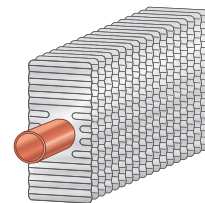

35 x 78 mm

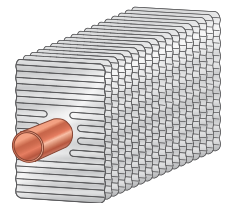

56 x 78 mm

For more details see chapter 2.3.

Part No.	Aluminium louvres	PKU	Weight/PKU
HLm18-01	35 x 78 mm (mini)	Carton with 1 x 2500 mm	2.2 kg
HLm18-06	35 x 78 mm (mini)	Carton with 6 x 2500 mm	11.0 kg
HL18-01	56 x 78 mm	Carton with 1 x 2500 mm	2.7 kg
HL18-04	56 x 78 mm	Carton with 4 x 2500 mm	10.0 kg

PG 060

Classic bracket sets

made of glass fibre reinforced polypropylene, white, complete incl. affixing material. Consumption approx. 1.5 pcs./m.

Part No.	Type	PKU	Height	Depth	Weight/PKU
V200-01	mini	1 set	130 mm	44 mm	60 g
V200-10	mini	10 sets	130 mm	44 mm	600 g
V210-01	Ia	1 set	200 mm	65 mm	80 g
V210-10	Ia	10 sets	200 mm	65 mm	800 g
V230-01	IIa + IIIa	1 set	200 mm	88 mm	100 g
V230-10	IIa + IIIa	10 sets	200 mm	88 mm	1 kg

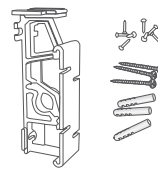

mini

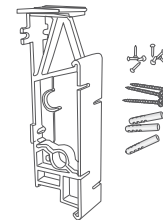

Ia

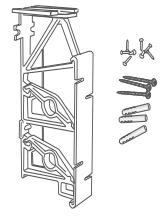

IIa + IIIa

PG 062

Classic extension set

For retrofitting the Delta bracket set to the Classic bracket set

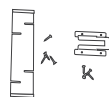

Part No.	Type	PKU	Weight/PKU
V2005-01	mini	1 set	30 g
V2005-10	mini	10 sets	300 g
V2105-01	Ia	1 set	30 g
V2105-10	Ia	10 sets	300 g
V2305-01	IIa + IIIa	1 set	35 g
V2305-10	IIa + IIIa	10 sets	350 g

PG 062

Skirting heating connection set 16

For attaching the pre-insulated Vario-modular pipes on the floor below the ends of the skirting heating before the floor (screed) is laid

1 set consisting of: 2 insertion brackets, 2 safety wedges, 2 folding collars

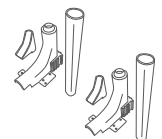

Part No.	PKU	Weight/PKU
Z101	1 set	200 g

PG 062

2.2 Overview – Delta skirting heating

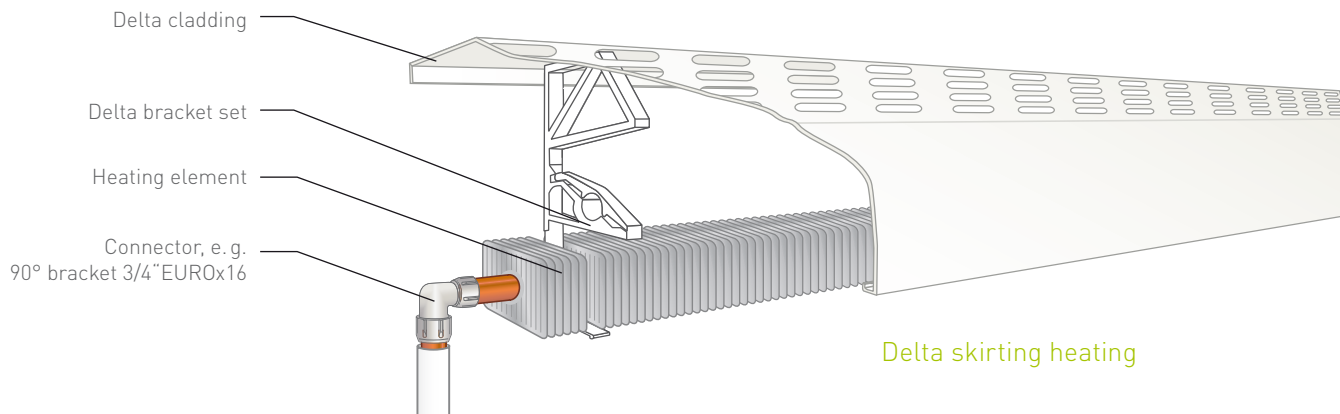

Delta skirting heating

Heating elements

PG 060

- Copper pipe $\varnothing 18 \times 0.5$ mm
- Aluminium louvres 35×78 mm (mini) or 56×78 mm
- Suitable for low temperature
- Optimised heat transfer
- Austrian seal of quality



For more details see chapter 2.3.

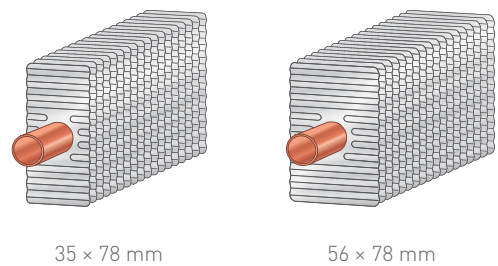

35 x 78 mm

56 x 78 mm

Part No.	Aluminium louvres	PKU	Weight/PKU
HLm18-01	35 x 78 mm (mini)	Carton with 1 x 2500 mm	2.2 kg
HLm18-06	35 x 78 mm (mini)	Carton with 6 x 2500 mm	11.0 kg
HL18-01	56 x 78 mm	Carton with 1 x 2500 mm	2.7 kg
HL18-04	56 x 78 mm	Carton with 4 x 2500 mm	10.0 kg

Delta claddings

PG 061

Completed and packed in cartons, 1.0 mm steel sheet, galvanised, powder-coated in RAL 9001 (Cream) as standard, special colours for a min. surcharge of 30 %!

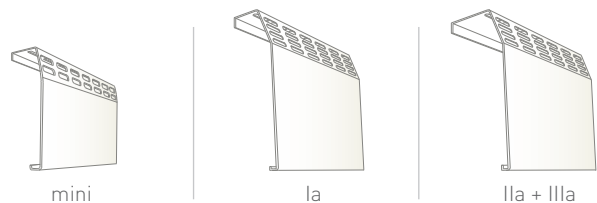

mini

la

Ila + IIIa

Part No.	Type	PKU	Weight/PKU
V1100	mini	Carton with 1500 mm	2.2 kg
V1110	la	Carton with 1500 mm	3.3 kg
V1123	Ila + IIIa	Carton with 1500 mm	3.6 kg

Delta bracket sets

PG 062

Made of glass fibre reinforced polypropylene, white, complete incl. affixing material. Consumption approx. 1.5 pcs./m.

Part No.	Type	PKU	Height	Depth	Weight/PKU
V1200-01	mini	1 set	130 mm	41 mm	50 g
V1200-10	mini	10 sets	130 mm	41 mm	500 g
V1210-01	la	1 set	200 mm	62 mm	70 g
V1210-10	la	10 sets	200 mm	62 mm	700 g
V1223-01	Ila + IIIa	1 set	200 mm	85 mm	90 g
V1223-10	Ila + IIIa	10 sets	200 mm	85 mm	900 g

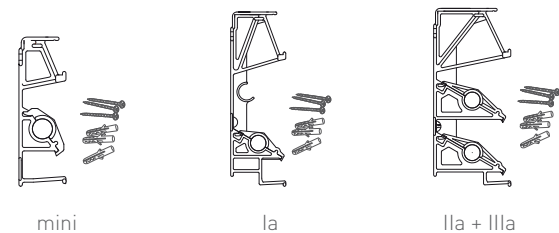

mini

la

Ila + IIIa

Delta inside and outside corner

PG 061

For covering the butt joints of the Delta cladding with inside and outside corners, powder-coated in RAL 9001 (Cream) as standard, special colours for a min. surcharge of 30 %!

Part No.	Type	Design	PKU	Weight/PKU
V1300	mini	Inside corner 90°	1 pce.	60 g
V1301	la	Inside corner 90°	1 pce.	120 g
V1302	Ila + IIIa	Inside corner 90°	1 pce.	140 g
V1350	mini	Outside corner 90°	1 pce.	90 g
V1351	la	Outside corner 90°	1 pce.	175 g
V1352	Ila + IIIa	Outside corner 90°	1 pce.	230 g

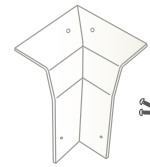

Inside corner 90°

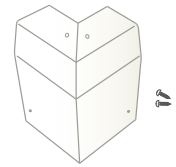

Outside Corner 90°

End cap, Delta, left

PG 061

Cladding end completion element, Delta, powder-coated in RAL 9001 (Cream) as standard, special colours for a min. surcharge of 30 %!



Part No.	Type	PKU	Weight/PKU
V1400	mini	1 pce.	60 g
V1401	la	1 pce.	120 g
V1402	Ila + IIIa	1 pce.	160 g

End cap, Delta, right

PG 061

Cladding end completion element, Delta, powder-coated in RAL 9001 (Cream) as standard, special colours for a min. surcharge of 30 %!



Part No.	Type	PKU	Weight/PKU
V1450	mini	1 pce.	60 g
V1451	la	1 pce.	120 g
V1452	Ila + IIIa	1 pce.	160 g

Connector, Delta

PG 061

For covering the butt joints with straight continuation of Delta cladding, powder-coated in RAL 9001 (Cream) as standard, special colours for a min. surcharge of 30 %!



Part No.	Type	PKU	Weight/PKU
V1250	mini	1 pce.	45 g
V1251	la	1 pce.	60 g
V1252	Ila + IIIa	1 pce.	60 g

Touch-up paint pen

PG 061

12 ml, for metal cladding RAL 9001 (Cream)



Part No.	PKU	Weight/PKU
V51	1 pce.	30 g

Skirting heating connection set 16

PG 062

For attaching the pre-insulated Vario-modular pipes on the floor below the ends of the skirting heating before the floor (screed) is laid

1 set consisting of: 2 insertion brackets, 2 safety wedges, 2 folding collars

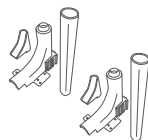

Part No.	PKU	Weight/PKU
Z101	1 set	200 g

Round hole-breaker

PG 140

For exactly breaking out the opening in the cladding for the Delta skirting heating systems

Hole sizes:

- 40 mm: for Delta mini
- 55 mm: for Delta la, Ila, IIIa types and for T114S, T116LS, T116RS

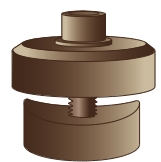

Part No.	ø hole	PKU	Weight/PKU
W010	40 mm	1 pce.	420 g
W011	55 mm	1 pce.	820 g

2.3 Heating elements

The specially developed heating elements from Variotherm are the technical core component of the Variotherm skirting heating systems. Highly efficient when it comes to performance. Optimised heat output.



The heating elements consist of a copper pipe $\varnothing 18 \times 0.5$ mm (DIN EN 12449) with aluminium louvres 56×78 mm or 35×78 mm (mini). The special manufacturing process results in a connection between the pipe and the aluminium louvres with an unsurpassed performance.

The heating elements are delivered packaged in boxes with a length of 2.5 m. They can be shortened as required using pipe cutting pliers, while longer heating elements are pressed together using 18 mm fittings (couplings, brackets etc.). Copper pipes can also be soldered.

Pipe material	Support sleeve	Viega		Sanha	
		Press fitting	Press-fitting jaws	Press fitting	Press-fitting jaws
Copper	Yes	Profipress Sanpress	V18	Press fitting series 6000/8000	SA18

▲ Table of suitable press fittings

2.4 Accessories for connection to the VarioManifold

Pre-insulated 16x2 Variomodular pipe PG 130

- Aluminium multi-layer composite pipe 16x2 (PE-RT/AL/PE)
- No oxygen diffusion whatsoever
- 70 °C, 6 bar
- Insulation: Polyethylene soft foam
Fire resistance as per EN 14313: C_L-s1,d0

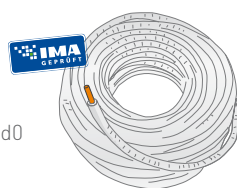

Part No.	Insulation thickness	PKU	Weight/PKU
V1226	6 mm	Roll with 100 m	14.0 kg
V1227	9 mm	Roll with 100 m	14.9 kg

Elbow union PG 100

For all skirting heating types, 90° elbow connector, clamping screw fitting Cu 18 for the heating element (incl. support sleeve), 3/4" Eurocone for the connection line. (Do not forget the clamping screw fitting!)

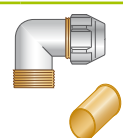

Part No.	PKU	Weight/PKU
Z38	1 pce.	260 g

Retaining clamp $\varnothing 35$ PG 130

for affixing the pre-insulated Vario-modular pipes.



Part No.	Variant	PKU	Weight/PKU
V2802	single	50 pcs.	1 kg
V2803	double	25 pcs.	1 kg

2.5 Accessories for connection to the two-pipe system

Flow valve with top piece

PG 062

1/2" valve with air vent, can be pre-set, with top piece at option, incl. clamping screw fitting 3/4" EUROxCu18 [Z136] + support sleeve [Z133] for the heating element, 3/4" Eurocone for the connection line (do not forget the clamping screw fitting!)

	Thermostatic valve	Thermostatic valve with remote sensor (5 m cable)	Handwheel	Actuator
				
1/2" valve, Straight-flow, two air vents	Part No. Z114	Part No. Z114V	Part No. Z115	Part No. Z114S
	Part No. Z116L	Part No. Z116LV	Part No. Z117L	Part No. Z116LS
	Part No. Z116R	Part No. Z116RV	Part No. Z117R	Part No. Z116RS

Air vent elbow, manual

PG 062

90° air vent bracket, incl. clamping screw fitting Cu 18 for the heating element (with support sleeve), 3/4" Eurocone for the connection line (do not forget the clamping screw fitting!)

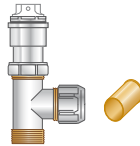

Part No.	PKU	Weight/PKU
Z119	1 pce.	300 g

Return valve

PG 062

1/2" valve incl. clamping screw fitting Cu 18 for the heating element (with support sleeve), 3/4" Eurocone for the connection line (do not forget the clamping screw fitting!), can be pre-set

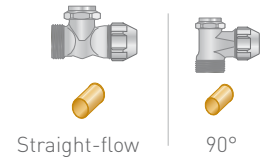

Part No.	Design	PKU	Weight/PKU
Z129	Straight-flow	1 pce.	200 g
Z130	90° corner	1 pce.	200 g

2.6 Connection accessories

Support sleeve 18 x 17 mm

PG 062

for the heating element with copper pipe, used for clamping screw fittings and copper press-fit connectors



Part No.	PKU	Weight/PKU
Z133	1 pce.	6 g

Connection set for IIIa skirting heating

PG 062

For connecting 2 heating elements. Centre to centre 58 mm. Consisting of 2 push fittings: 1x 90° i/a and 1x 90° i/i

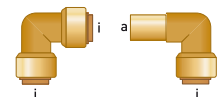

Part No.	PKU	Weight/PKU
Z112	1 set	142 g

3 PIPING WITH THE VARIOMANIFOLD

3.1 Description

For installations with manifold systems, first lay the pre-insulated Variomodular pipes from the manifold to the skirting heating and back, and then connect them to the manifold via a screwed fitting. The Variomodular pipe should be routed endlessly (i.e. without additional connecting elements) from the manifold to the skirting heating. The pipe is positioned near the skirting heating with the installation bracket.

Electronic room thermostats and thermoelectric actuators are used to control the room temperature.

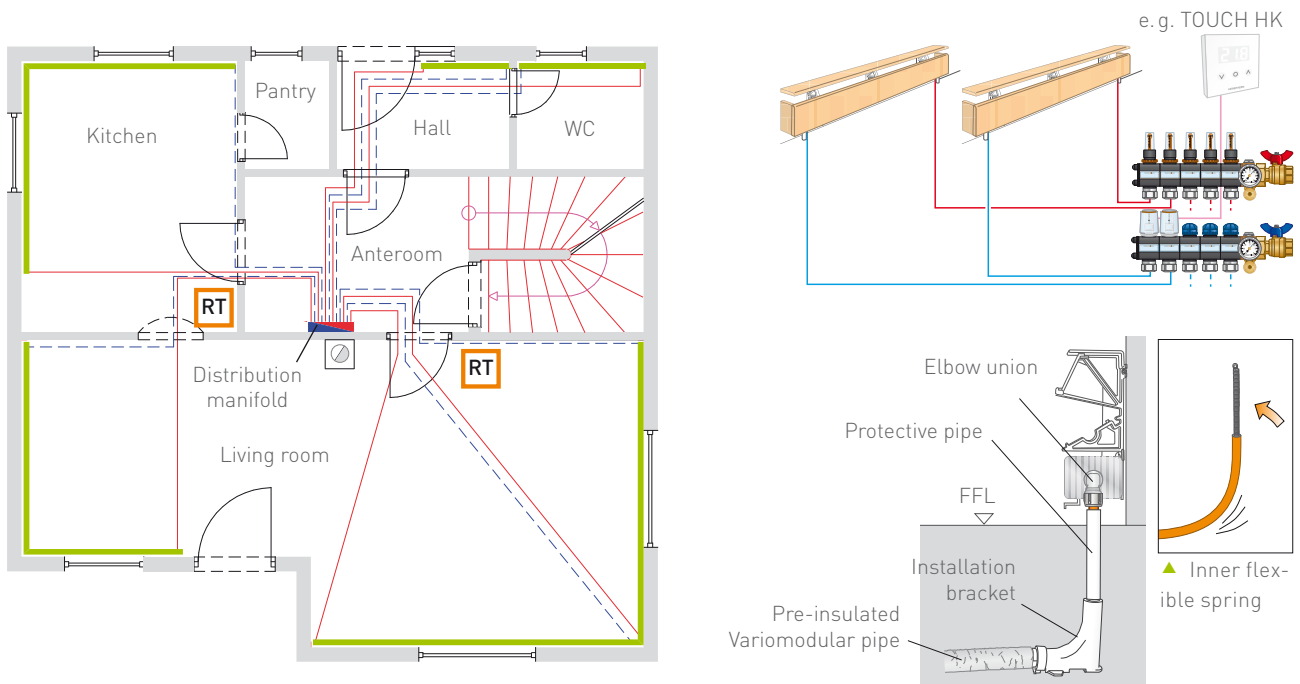

▲ Laying example with Variotherm distribution manifold

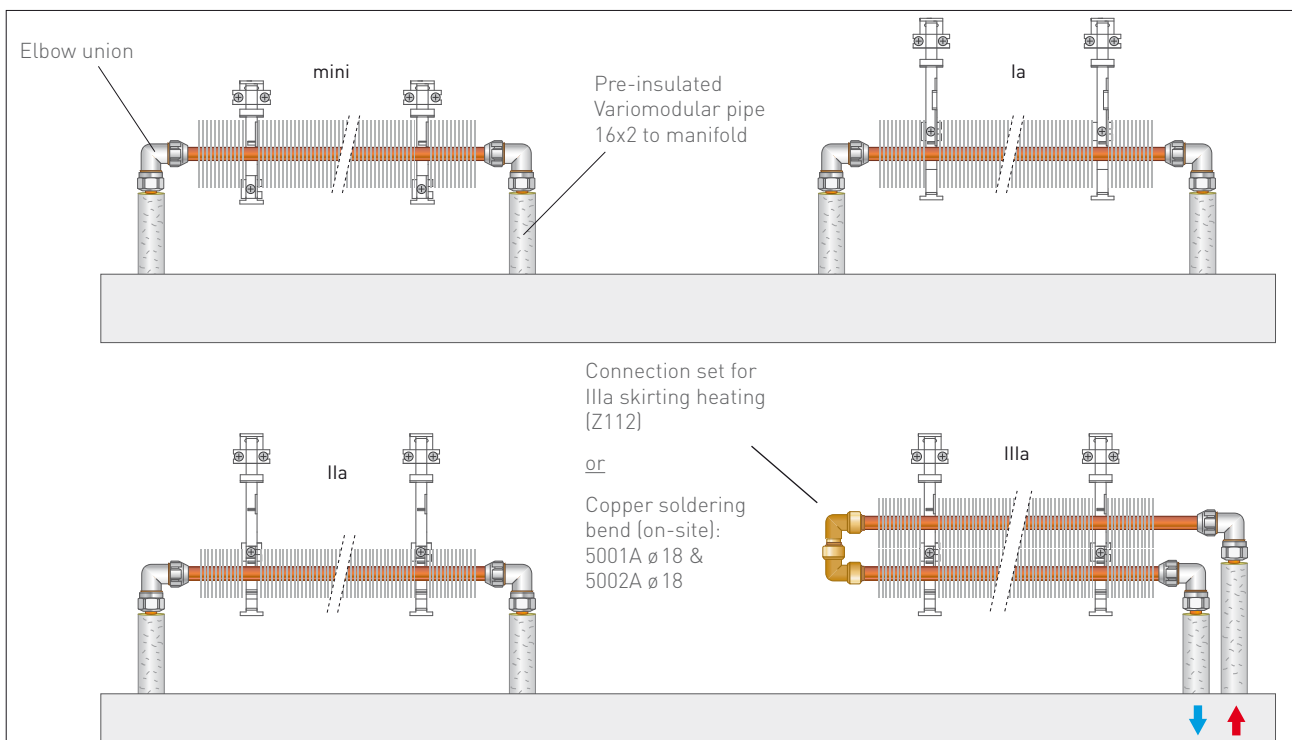

3.2 Piping components

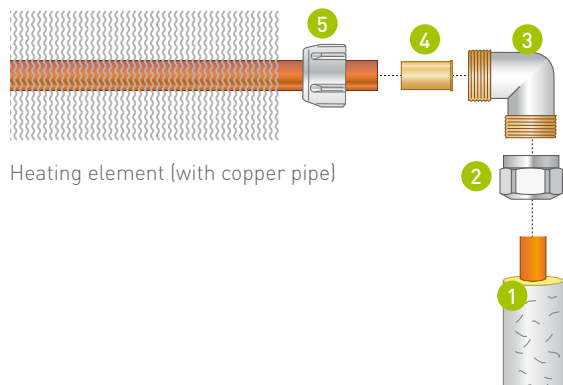

Heating element (with copper pipe)

Venting

Venting is performed by flushing and the air vents installed on the distribution manifold.

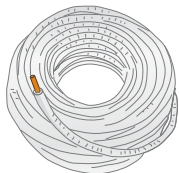

1 Pre-insulated Variomodular pipe 16x2

Aluminium multi-layer composite pipe (PE-RT/AL/PE-RT), orange, no oxygen whatsoever, 95 °C, 10 bar. Insulation: Polyethylene soft foam, 6 or 9 mm insulation thickness

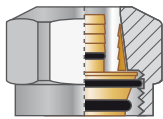

2 Clamping screw fitting 3/4" EUROx16

Especially developed for Variotherm pipes on a 3/4" Eurocone, nickel-plated, single-piece, with metallic clamping ring and galvanic isolation, AF 30, tested according to EN 21 003

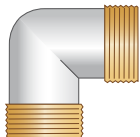

3 90° bracket 3/4" EURO

nickel-plated, 3/4" Eurocone on 3/4" Eurocone



4 18x17 mm support sleeve

Used for clamping screw fittings and for press-fit connectors at heating elements with copper pipe



5 3/4" EUROxCu18 clamping screw fitting

3/4" Eurocone on Cu18, nickel-plated, with EPDM sealing element, for \varnothing 18 mm copper pipes as per DIN EN 1057 and \varnothing 18 mm stainless steel pipes as per DIN EN 10312, pipe wall thickness \geq 1 mm

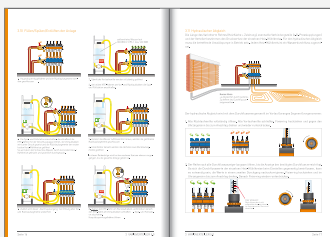

<< Details regarding the system and heating circuit pipes and the room temperature control are provided in the DISTRIBUTION and CONTROL planning and installation instructions

4 PIPING WITH A TWO-PIPE SYSTEM

4.1 Description

For installation in the two-pipe system, flow valves with an integrated air vent are used to control the room temperature. The return valves are used to shut off and set the water quantity (hydraulic balancing).

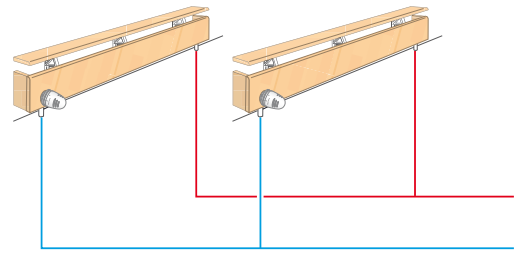
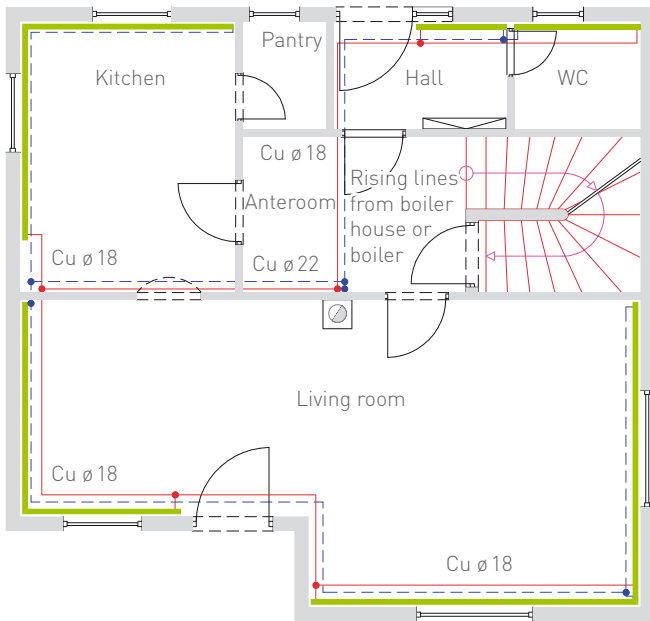

▲ Laying example with 2-pipe system

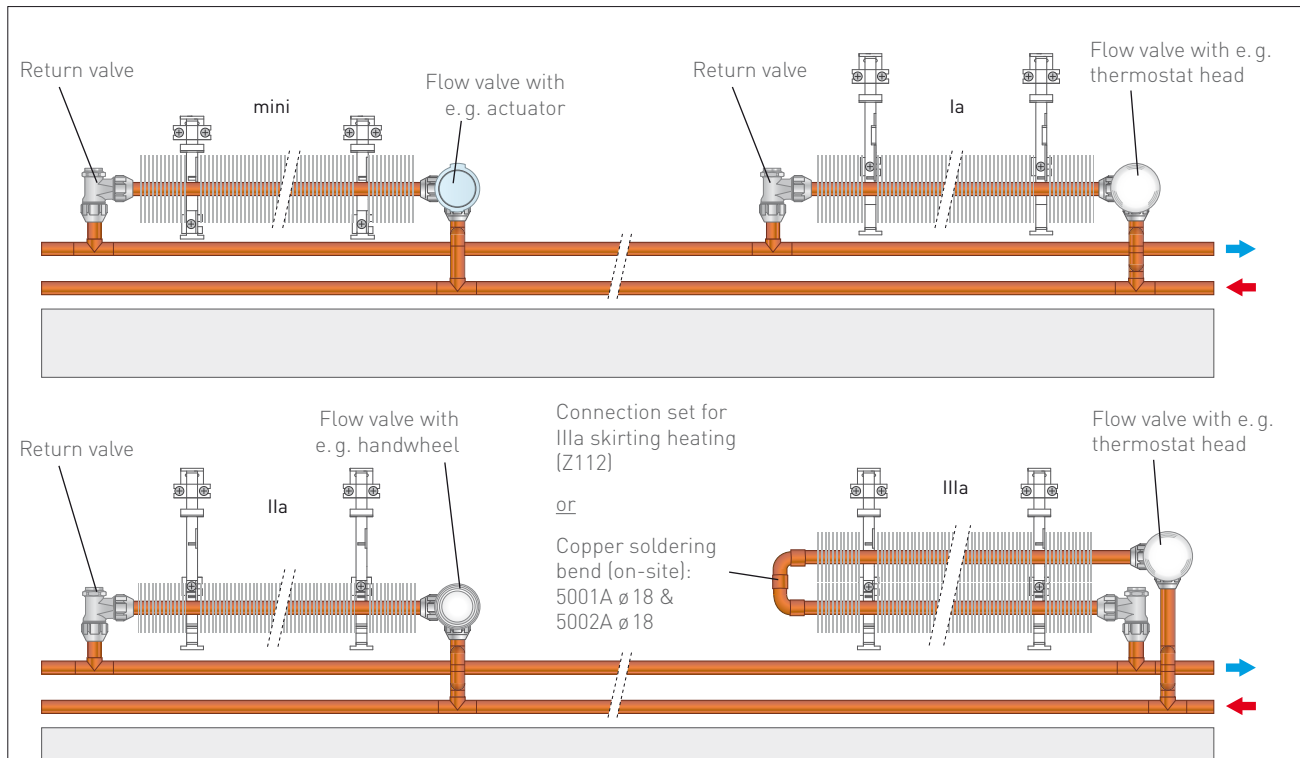

4.2 Supply pipes inside the cladding

Variotherm tip: If necessary (old building with finished floors etc.), additional uninsulated pipes to max. 18 mm external diameter can also be held in the brackets.

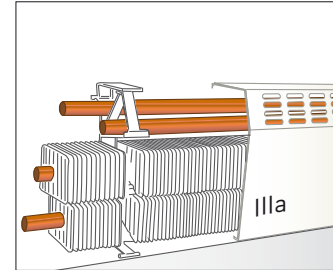
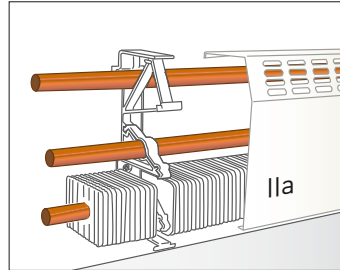
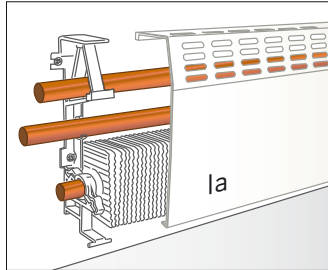

4.3 Vent

The individual skirting heating systems are vented via the flow valves with integrated manual venting systems. The air vent elbow is inserted in the return for valves without integrated venting systems.

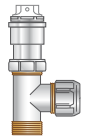

4.4 Piping components

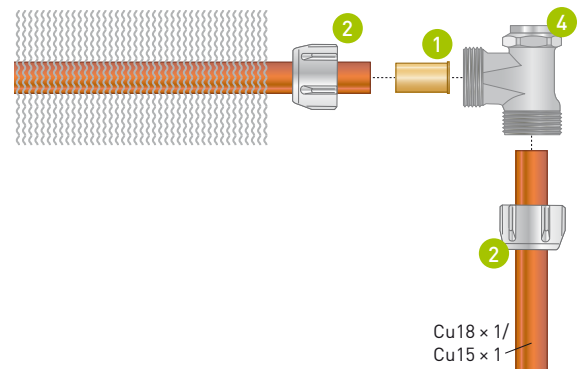
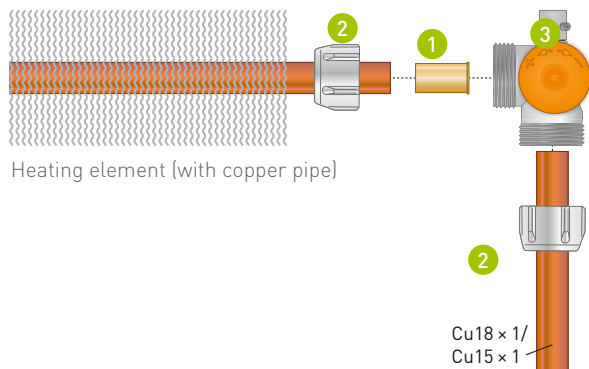

1 18 x 17 mm support sleeve

Used for clamping screw fittings and for press-fit connectors at heating elements with copper pipe



2 3/4" EUROxCu18 (or Cu15) clamping screw fitting

3/4" Eurocone on Cu18, nickel-plated, with EPDM sealing element, for \varnothing 18 mm copper pipes as per DIN EN 1057 and \varnothing 18 mm stainless steel pipes as per DIN EN 10312, pipe wall thickness \geq 1 mm (also available for 15 mm pipes)

3 Flow valve

The flow valve with integrated air vent is available in left, right or continuous versions.

On delivery, there is a protective plastic cap on the valve spindle. This allows the valve to be opened or closed without a valve head. The flow valve can be used for hydronic balancing. So using the return valve for hydraulic balancing wouldn't be required no more. Before mounting a valve head or presetting the valve, the protective plastic cap is removed.

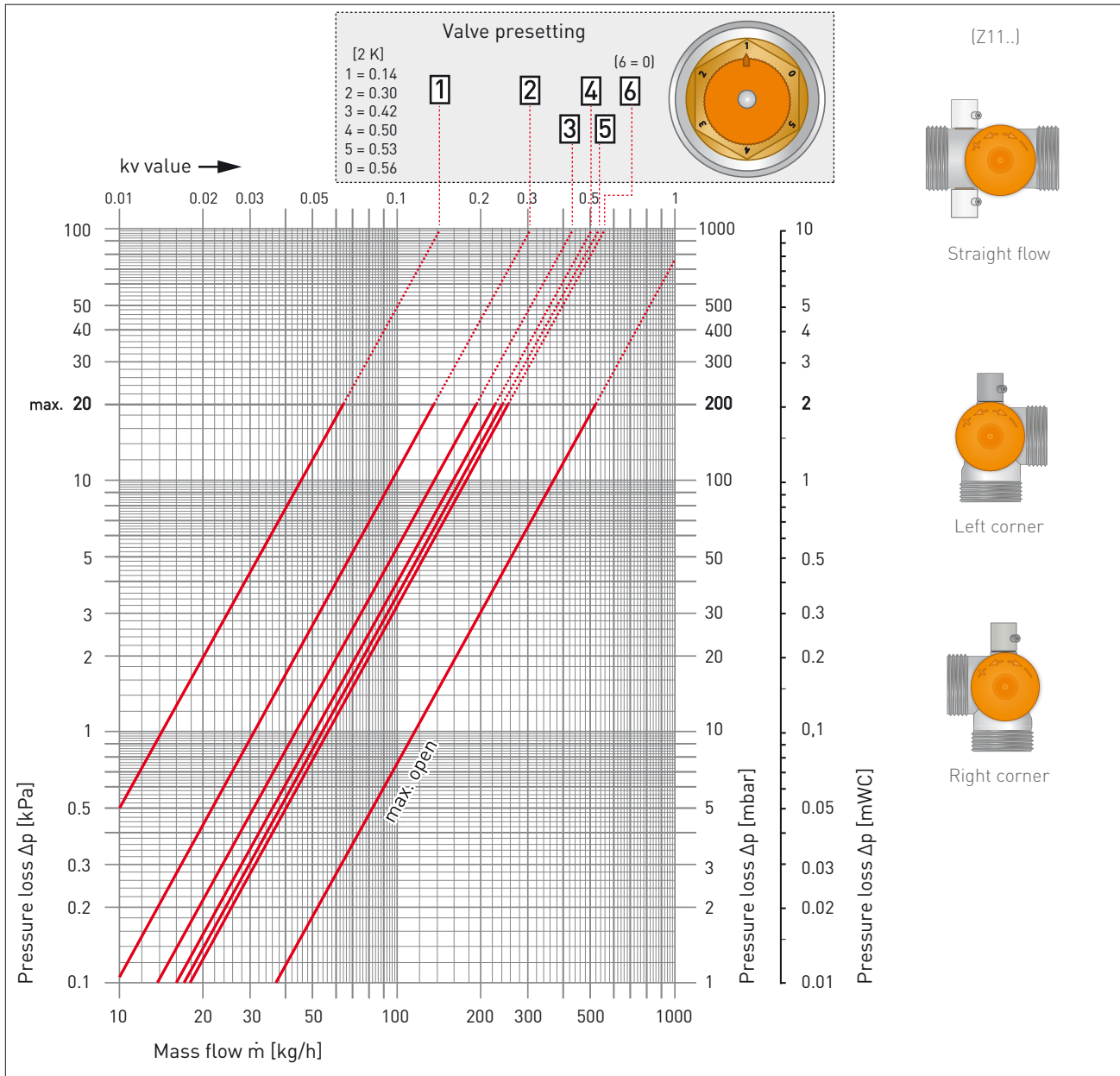

	kv value							
System deviation	0.5 K	1 K	1.5 K	2 K	2.5 K	3 K	3.5 K	4 K
Presetting 1	0.05	0.11	0.14	0.14	0.14	0.14	0.14	0.14
Presetting 2	0.13	0.25	0.29	0.30	0.30	0.30	0.30	0.30
Presetting 3	0.14	0.26	0.38	0.42	0.44	0.44	0.45	0.45
Presetting 4	0.14	0.27	0.39	0.50	0.54	0.55	0.56	0.57
Presetting 5	0.15	0.28	0.40	0.53	0.66	0.70	0.72	0.73
Presetting 6 (=0)	0.15	0.28	0.41	0.56	0.70	0.76	0.80	0.81

Valve heads for flow valves:

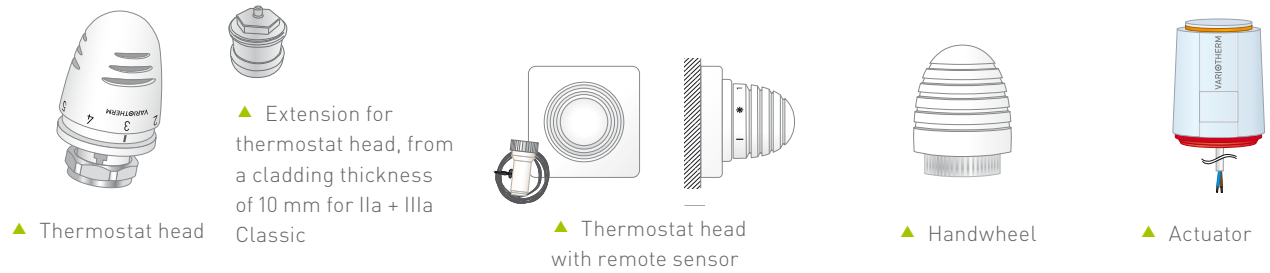

4 Return valve

The return valve is used for hydronic balancing and as a shut-off valve if the heating elements have to be dismantled (e.g. for painting). The valve spindle is under the protective cap. The return valve can be closed by rotating it.

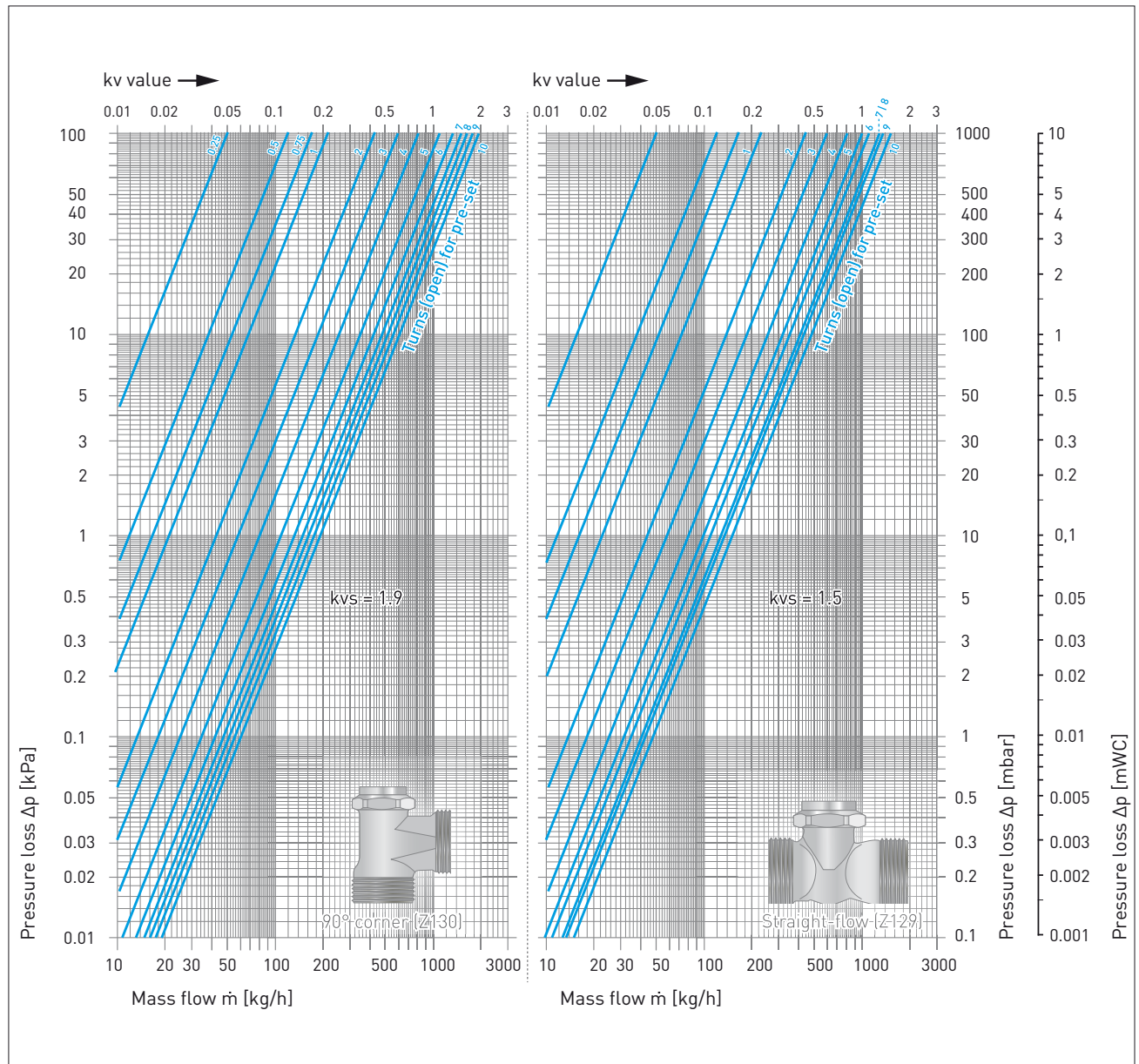

5 THERMAL OUTPUT

5.1 Calculation of the thermal load

Along with the respective national annex, the EN 12831 standard will be used to calculate the heating load for the heated rooms.

Every room is considered individually. For the outside temperature, the locally acquired and standardised outdoor temperature T_{ne} is used.

Übersicht der Bauteile

Code	Bezeichnung	U-Wert W/m²K	Rges m²K/W	Rsi m²K/W	Rse m²K/W	R-Baut m²K/W
AF01	Außenfenster	1.100	0.909	0.130	0.040	0.739
AT01	Außentür	1.700	0.588	0.130	0.040	0.418
AW01	Außenwand	0.220	4.545	0.130	0.040	4.375

Raum		Φ_{ext}	A_{ext}	Φ_{tr}	Φ_{v}	$\Phi_{ventilator}$	$\Phi_{Rohrnet}$	Φ_{Rohr}	Φ_{Rohr}	Φ_{HL}	
Nr.	Bezeichnung	°C	m²	W	W	W	W	W	W	W	
Haus_EG			180.88	5427		3396			9160	0	9160
00.001.001	Eldern	20.0	29.10	833	833	501	46	15	1335	0	1335
00.001.002	Kinder	20.0	20.49	762	762	343	54	19	1106	0	1106
00.001.003	Vorraum	20.0	24.40	571	571	409	40	14	980	0	980
00.001.004	Baum	20.0	19.26	560	560	420	21	8	981	0	981

▲ Extract from a heating load calculation

5.2 Variotherm dimensioning software

Key values for individual heating circuits (the amount of water, pressure loss, number of circuits, allocation of the manifolds etc.) can be quickly and easily calculated by inputting the heating load into the Variotherm dimensioning software. It can be found in our Professional Area at www.variotherm.com/profi.

Dimensioning of Variotherm Heating Systems

Building project: John Doe ZIP: 2544 City: Leobersdorf Date: Processed by:

No.	Room name	Floor space	Maximum length of DCH or SH	Heating load	Suggestion heating load	Heating load incl. Supplement	Room temp.	Heat transfer system	Floor covering	Dimensioning temperature	Mathematical			Practical			Supply pipe	Supply line length	Pressure loss per circuit [mWC]	Flow quantity per circuit [l/s]	Distribution manifold number
											Dim.	Unit	Type	No. of circuits	Dim.	Unit					
	Workroom		3,00	842		842	20	Skirting heating		50/45	3,00 m	HL IIIa	1	3,00 m	HL IIIa	206	-	0,04	182	•1	
	Bathroom		3,00	355		355	24	Skirting heating		50/45	1,90 m	HL Ia	1	3,00 m	HL Ia	212	-	0,01	98	•1	
	Storage 1		1,50	123		123	20	Skirting heating		50/45	0,98 m	HL mini	1	1,50 m	HL mini	66	-	0,00	33	•1	
	Storage 2		1,50	168		168	20	Skirting heating		50/45	1,33 m	HL mini	1	1,50 m	HL Ia	147	-	0,00	55	(•1)	
	Wellness		10,00	2362		2362	24	Skirting heating		50/45	9,30 m	HL IIIa	2	5,00 m	HL IIIa	196	-	0,04	221	•1	
	Hall		12,00	3160		3160	20	Skirting heating		50/45	11,10 m	HL IIIa	2	5,00 m	HL IIIa	260	-	0,08	295	•1	
	Corridor		8,40	1621		1.621	20	Skirting heating		50/45	7,80 m	HL Ia	2	4,20 m	HL Ia	143	-	0,02	153	•1	
	Anteroom		1,50	274		274	20	Skirting heating		50/45	1,40 m	HL Ia	1	1,50 m	HL Ia	154	-	0,00	74	(•1)	

Summary of the heating systems			
Amount	Unit	Heating system	Type
	m²	System wall heating	SWHK2
	m²	System wall heating	SWHK3
	m²	Modular wall heating	MSW
	m²	EasyFlex wall heating	EWHT7F
	m²	EasyFlex wall heating	EWHT7
	m²	EasyFlex wall heating	EWHT15
	m²	Modular ceiling heating	MSD/MRD
	m²	Screed floor heating	RA10
	m²	Screed floor heating	RA15
	m²	Screed floor heating	RA20
	m²	Screed floor heating	RA25
	m²	Screed floor heating	RA30
	m²	Compact floor heating	RA10
	m²	Compact floor heating	RA20
1,5	m	Skirting heating	HL mini
12,9	m	Skirting heating	HL Ia
23,5	m	Skirting heating	HL IIIa
3,0	m	Skirting heating	HL IIIa
	m	Ducted channel heating	BKH1 mini
	m	Ducted channel heating	BKH1
	m	Ducted channel heating	BKH2 mini
	m	Ducted channel heating	BKH2
	m	Supply pipe	16x2
	m	Supply pipe	11.6x1.6

Summary of pipe length by line			
Line	Room	m ± 0.1	m ± 11.6
1	Workroom	14	
2	Bathroom	15	
3	Storage 1	16	
4	Storage 2	17	
5	Wellness	18	
6	Hall	19	
7	Corridor	20	
8	Anteroom	21	
9		22	
10		23	
11		24	
12		25	
13	TOTAL		

Summary of the floor heating surface area	
Room	m²
Screed floor heating	
Compact floor heating	

Summary of loads	
Room	m²
Total heating load	8.905 W
Total installed load	10.293 W

Manifold	t/rt	Number of heating circuits	Flow quantity manifold [kg/h]	Max. pressure loss ± 0.1 mWC for manifold [mWC]	Manifold notation according to drawings
Distribution manifold #1	50/45	9	1760	0,18	
Distribution manifold #2					
Distribution manifold #3					
Distribution manifold #4					
Distribution manifold #5					

These 5 distribution manifolds are fed via one pump, the following applies:

Total flow quantity:	1760	kg/h
Maximum pressure loss from distribution manifold incl. 0.1mWC for max. opened valve	0,18	mWC

▲ Variotherm dimensioning software example for heating

6 DIMENSIONING

6.1 General planning principles

In the planning phase, not only selecting the right heating system is important. Information on building quality such as room size, ceiling heights, door and window sizes, construction materials and thermal resistance values are important when determining the heat requirements and the dimensioning of the skirting heating system. During this time, you can also choose various parapet heights below large windows (for a highly effective hot air veil) and niches for installing the heating elements and their cladding.

When planning the sockets, ensure that they are located above the skirting heating. We recommend providing sockets at a height of 350 mm above the finished floor level.

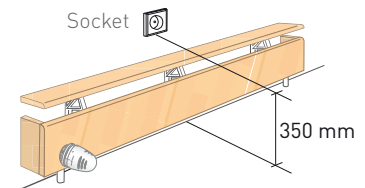

The dimensioning of the skirting heating system depends on

- The flow temperature
- The required output
- The possible installation length

Planning the maximum flow temperature of the heating system is key to a healthy warmth provided by the skirting heating system. We recommend that the set-up temperature does not exceed 60 °C. Otherwise, the louvre temperature will be significantly above the dust carbonisation temperature, which can lead to unhealthy air. Best results are achieved with maximum flow temperatures of 50 to 55 °C.

Recommended maximum length of a heating circuit:

Type mini, Ia, IIa: 7.5 m (= 7.5 m heating element)

Type IIIa: 5.0 m (= 10 m heating element)

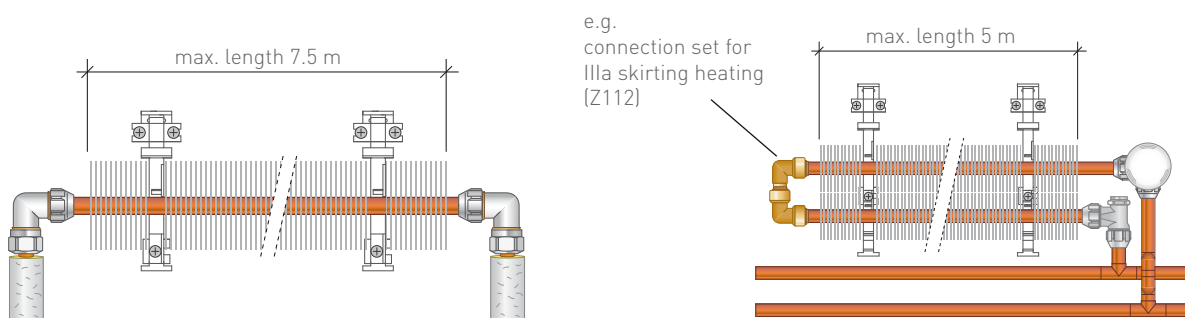

Ideal case:

Optimal radiant heat is achieved when the skirting heating system is installed along the entire length of the exterior walls. A tip from Variotherm: Fit at least 70 % of the exterior walls with skirting heating systems.

6.2 Positioning of the supply pipe

To prevent damage to the heating elements and cladding, they should not be fitted to the painted walls until the flooring is completed. The supply pipes are installed in accordance with the connection spacing shown above.

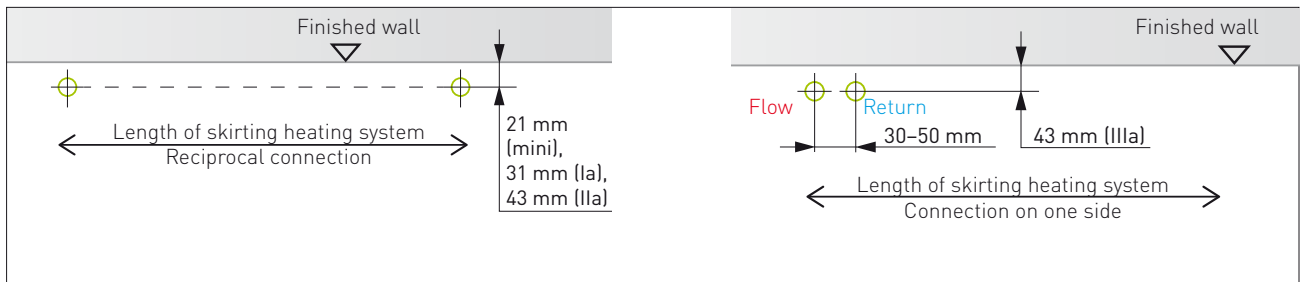

6.3 Skirting heating with special shapes (on request)

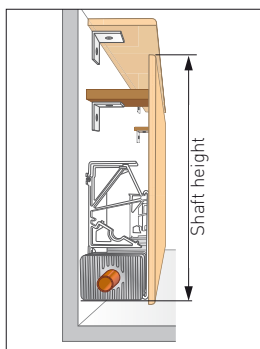
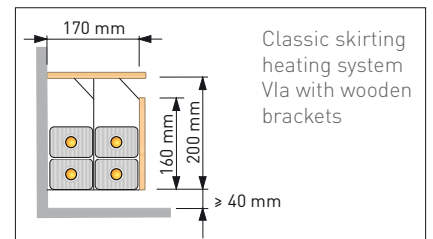
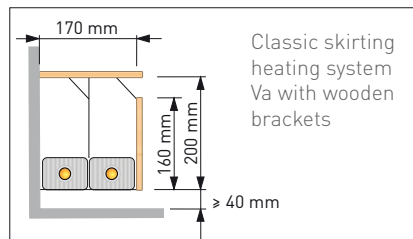
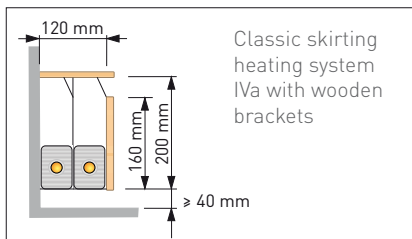

<< If the shaft height changes (= lower edge of the heating element to the upper edge of the front cladding) an additional fastening must be provided to secure the cladding (provided by the customer).

7 DETAIL DRAWINGS

mini Classic

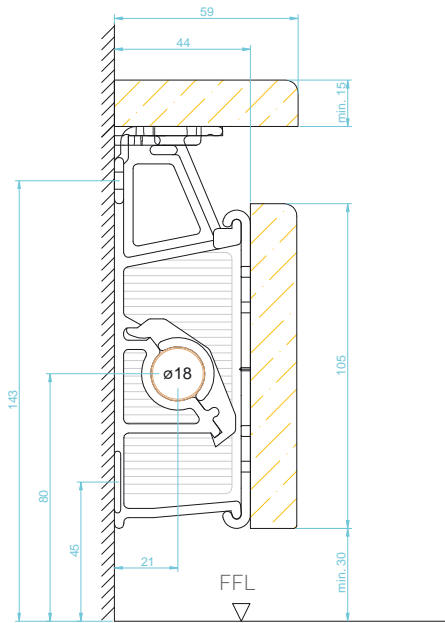

mini Delta

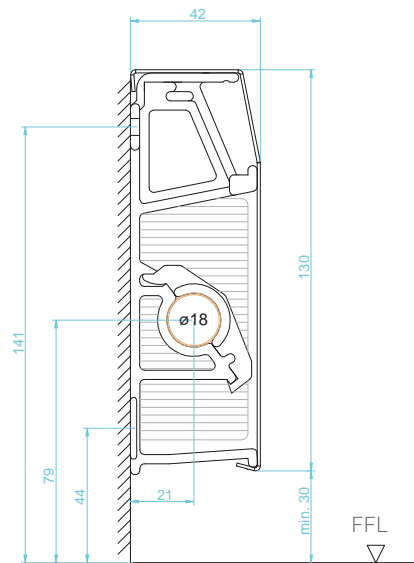

la Classic

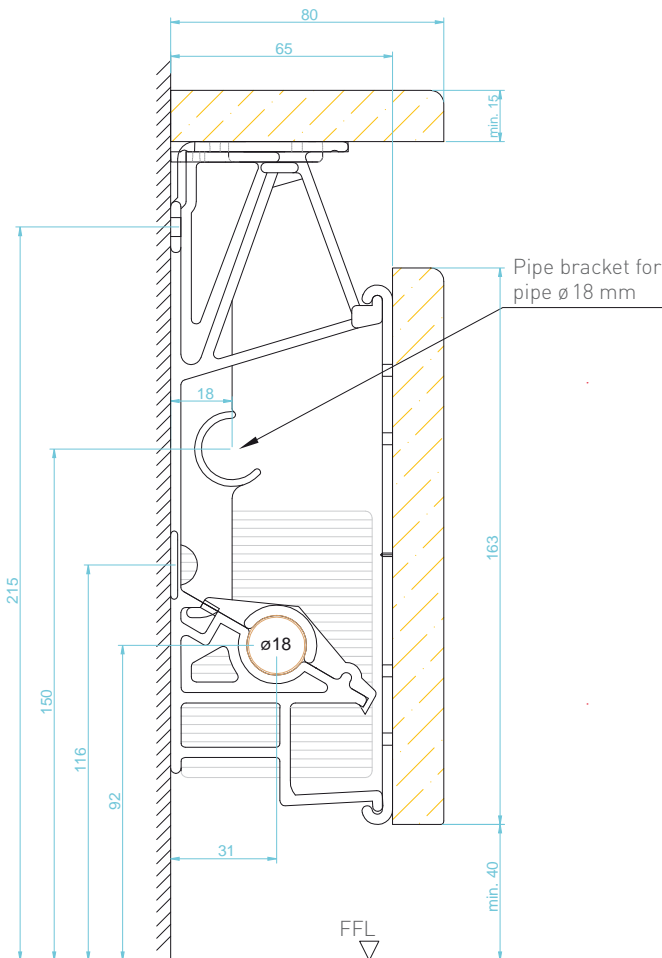

la Delta

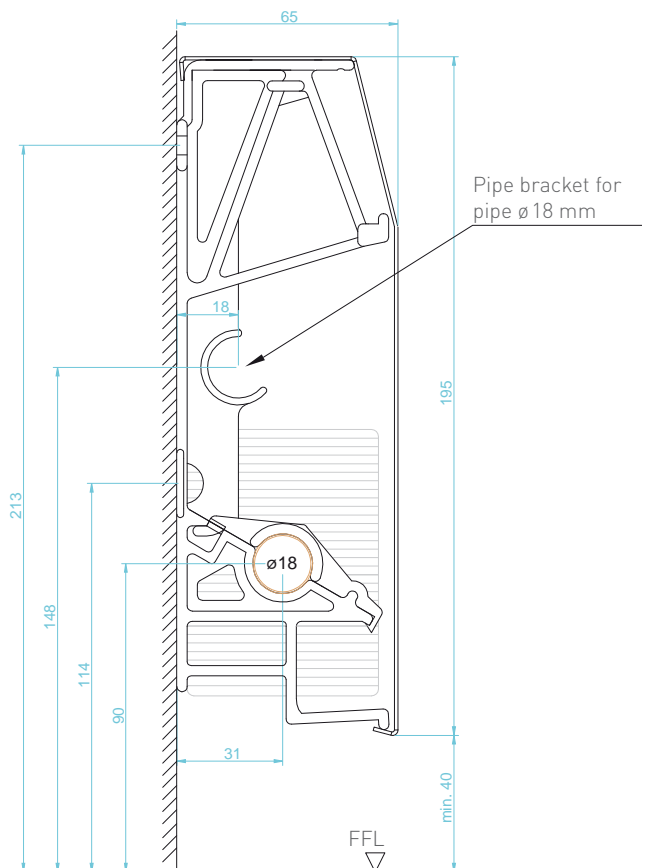

All dimensions in mm

ENJOY THE COMFORT & SAVE ENERGY

That's why our customers love us:

Heating and cooling optimised for COMFORT in all rooms!

Fast and friendly service, ANSWERS backed up with expertise!

Always in tune with the latest technology, INNOVATION guaranteed!

Everything CLEAR and SIMPLE, in writing of course!

PROFESSIONALISM at all times, from the first contact to the reference list!

VARIOTHERM SINCE 1979

Variotherm is an Austrian model plant with hundreds of partners in Austria, Europe and around the world.

All rights pertaining to distribution and translation, in whole or in part, including film, radio, television, video recording, Internet, photocopying and reprinting, are reserved. Subject to mistakes and printing errors. Misprints and errors excepted.



Austria's
Leading
Companies
2014



SH

VARIOTHERM HEIZSYSTEME GMBH

GÜNSELSDORFER STRASSE 3A

2544 LEOBERSDORF

AUSTRIA

T: +43 [0] 22 56 – 648 70-0

office@variotherm.com www.variotherm.com